

CLEARRAY™ LAMP REPLACEMENT AND QUARTZ TUBE MAINTENANCE

Important: It is **MANDATORY** that the UV lamp be replaced and the quartz tube be cleaned every 12 months to maintain optimum performance.

Available Service Parts (parts not listed are not available as spare parts):

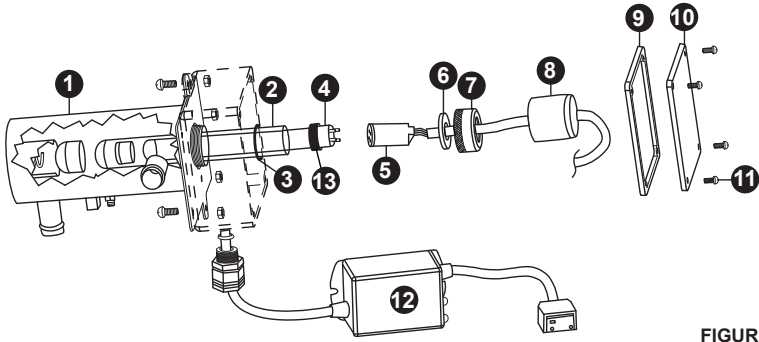

FIGURE 1

Item	Part Number	Description	Qty
1	6472-855	UV reactor chamber - 316L SS 110V	1
	6472-853	UV reactor chamber - 316L SS 220V	1
2	6472-859	Quartz tube	1
4	6472-857	UV lamp	1
6	6000-374	Quartz seal compression washer	1
7	6000-373	Quartz seal compression nut	1
9	6000-375	Electrical enclosure gasket	1
12	6000-372	Electronic ballast	1

! DANGER: TURN THE SPA BREAKER TO THE OFF POSITION!

! WARNING: ALLOW LAMP TO COOL DOWN PRIOR TO REMOVING FROM QUARTZ TUBE.

! DANGER: NEVER LOOK AT THE LIT BULB. THIS CAN CAUSE SEVERE EYE DAMAGE OR BLINDNESS.

UV lamp replacement and quartz tube maintenance:

NOTE: Location of **CLEARRAY** System and connection may vary by model.

1. Turn the breaker to the spa OFF. We recommend that you drain your spa. Disconnect the **CLEARRAY** System from the controller, Figure 2.
2. Once the UV lamp has cooled off remove the **CLEARRAY** System enclosure cover (10) and gasket (9) by removing the four screws (11).

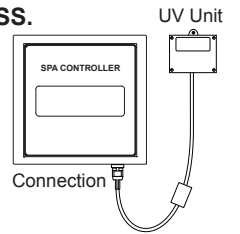

FIGURE 2

! DANGER: NEVER REMOVE COVER WITHOUT FIRST TURNING OFF AT POWER SOURCE.

3. Remove the black lamp boot (8) by sliding it over the cable away from the quartz seal compression nut (7), Figure 3.
4. Slowly remove the UV lamp (4) out of the quartz tube.
5. Remove lamp socket (5) from the UV lamp (4), Figure 4.
6. Remove the quartz seal compression nut (7) by turning it **counterclockwise**, Figure 3. Use a pair of channel-lock pliers if needed, Figure 5. You will notice that there is a stainless steel compression washer (6) which slides over the quartz tube, save the washer (6) for later use, Figure 6. There is also a black seal ring (13), grasp the black seal ring, slowly and carefully remove the quartz tube.
7. Now you are ready to clean or replace the quartz tube (2). For the cleaning quartz tube (2), follow steps 8 and 9 then proceed from step 10. For replacing quartz tube (2), skip steps 8 and 9 and proceed from step 10.
8. **Cleaning quartz tube:** Clean the quartz tube by wiping until clear using a paper towel or a dry cotton cloth. If needed a household tub and shower lime removal product can be used.

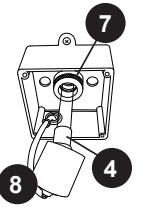

FIGURE 3

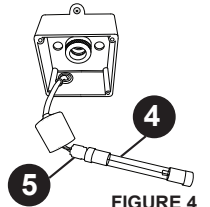

FIGURE 4

! WARNING: Do not use abrasive cleaners as they can scratch the quartz tube surface.

9. Rinse the quartz tube with clean water to completely remove any cleaning products that were used in step 4.
10. **Replacing quartz tube:** You will notice that the new quartz tube does not have a black cushion on the domed end as the old quartz tube does. This is normal as the cushion was provided to the original quartz tube to protect it from breakage during transportation. Install the black seal ring (13) over the opened end of the quartz tube. Place the new quartz tube (2) into the water chamber (1) with the domed end first making sure it is inserted and seated inside the quartz end holder. Only a small portion will be exposed when it is seated correctly.
11. Reinstall the compression washer (6) over the open end of the quartz tube (2). Push it against the quartz black seal ring (13).
12. Reinstall and hand tighten the quartz seal compression nut (7) by turning it **clockwise**.
13. Refill your spa.
14. **System Test 1:** Assure there is no water dripping from the seal compression nut (7). If water is visible, STOP and tighten the compression nut (7) using a pair of channel lock pliers to a maximum of 1/4 turn. If that does not fix the leak, then repeat quartz tube maintenance process from step 1 through step 13. Make sure there is no water leaking BEFORE proceeding to step 15.
15. **System Test 2:** Turn breaker back ON. Turn on the pump to circulate the water through the **CLEARRAY** System. Wait for 5 minutes and assure no water is dripping. If water is visible, STOP, fix the leak by repeating quartz tube maintenance process from step 1 through step 14. **Make sure there is no water visible and turn the pump and breaker OFF BEFORE proceeding to step 16.**
16. Reconnect the lamp socket (5) to the new UV lamp (4) make sure you use the latex glove provided when handling the UV lamp. **NOTE:** Align pins on UV lamp (4) to the receptacle holes on the lamp socket (5) before inserting the pins completely into socket holes. Failure to do so will damage the UV lamp.

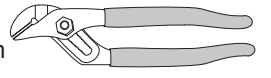

FIGURE 5

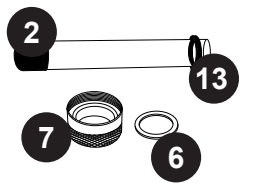

FIGURE 6

! WARNING: DO NOT TOUCH THE NEW UV LAMP WITH YOUR BARE HAND. Oil on your skin will cause hot spot on the UV lamp and shorten the life of your UV lamp. Use the provided latex glove to handle the UV lamp.

17. Slide the new UV lamp (4) back inside the quartz tube, Figure 3.
18. Reinstall the black lamp boot (8) back over the quartz seal compression nut (7).
19. Reinstall the enclosure cover (10) with gasket (9) and secure with the screws.
20. Reconnect the **CLEARRAY** System to the controller and turn on the power to the spa.
21. Properly dispose of the old UV lamp.

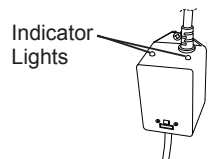

FIGURE 7

! WARNING: This **CLEARRAY** System includes a UV lamp, which contains mercury. Dispose of the lamp in accordance with disposal laws. See www.lamprecycle.org.

22. Once power is activated you can check the ballast (12), Figure 7, to see if the **CLEARRAY** System is functioning. A solid green light indicates that the **CLEARRAY** System is being provided power and should always be on. A solid red light indicates that UV lamp is activated.